

PH1010 104 (Upon Request)

Ø 10 mm • 2.1 mNm

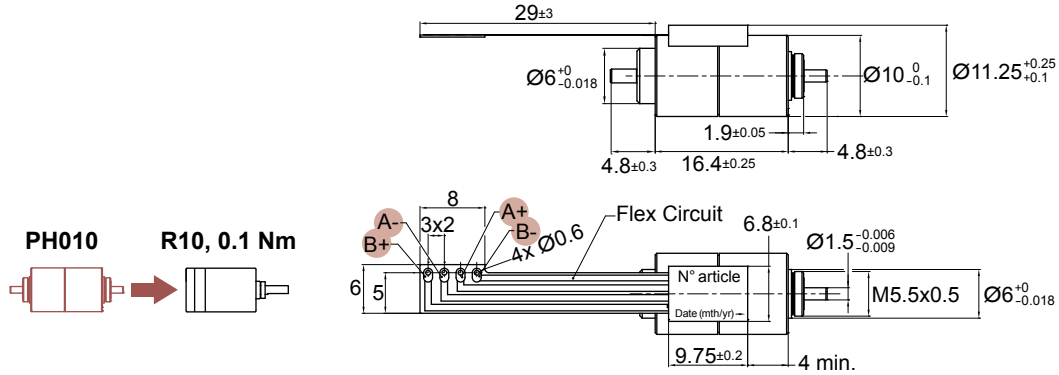

Dimensions in mm.

Electrical Data	020 04	PH1010 104 010 04	003 04	Unit
1 Resistance per Phase, typ	19.0	10.0	3.0	Ohms
2 Inductance per Phase, typ	8.4	4.2	1.3	mH
3 Nominal Phase Current (2 ph. On)	0.17	0.24	0.44	A
4 Nominal Phase Current (1 ph. On)	0.24	0.34	0.62	A
5 Back EMF Amplitude	1.58	1.18	0.64	V/kstep/s
General Data				
6 Holding Torque, nominal current		2.1 (0.3)		mNm (oz-in)
7 Holding Torque, 1.5x nominal current (1)		3.16 (0.45)		mNm (oz-in)
8 Detent Torque		1 (0.14)		mNm (oz-in)
9 Rotor Inertia		0.070		kgm ² x 10 ⁻⁷
10 Step Angle		9		Degree
11 Absolute Accuracy 2 ph. On, Full step mode		+/- 5%		% Full Step
12 Steps Per Revolution		40		
13 Ambient Temperature Range (operating)		-20 to 50 (-4 to 122)		°C (°F)
14 Maximum Coil Temperature		130 (266)		°C (°F)
15 Thermal Resistance Coil-ambient (2)		66		°C/W
16 Natural Resonance Frequency (nominal current)		276		Hz
17 Electrical Time Constant		0.42		ms
18 Angular Acceleration (nominal current)		301,758		rad/s ²
19 Bearing Type		Ball		
20 Dielectric Withstanding Voltage		500 VRMS for 5 seconds		VAC
21 Radial Shaft Play		30@2N		µm
22 Axial Shaft Play		40@2N		µm
23 Maximum Radial Shaft Load		2.5 (9)		N (oz)
24 Maximum Axial Shaft Load (3)		2.5 (9)		N (oz)
25 Weight		9 (0.32)		g (oz)
26 Power Rate (nominal current)		0.5		kW/s

Notes:

1. Measured with 1 phase ON. The max coil temperature must be respected
2. Motor unmounted
3. Shaft must be supported when press-fitting a pulley or pinion

Turbo Disc PH1010 104 003 Torque vs Speed
(full step bipolar drive)

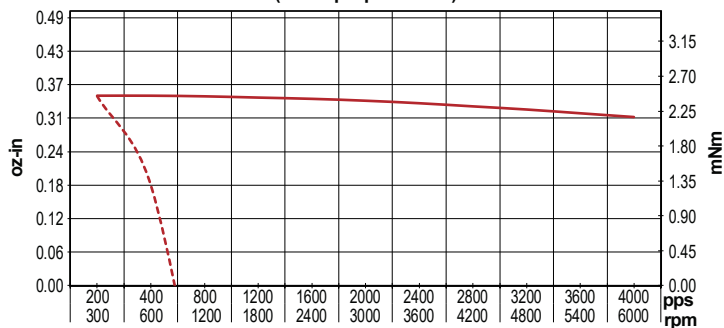

— PH1010 104 003 Pull-Out Torque @ 0.6A, 12V - - - PH1010 104 003 Pull-In Torque @ 0.6A, 12V